



WWW.ELICHENS.COM

Datasheet – Ultra-low power 4-Series sensor, Mulberry-CH4

Revision	Date	Description of Change
0.1	07/2020	Initial version
0.2	08/2020	Update and typos
0.3	12/2020	Confidentiality removed
0.4	08/2021	Update ATEX section
0.5	09/2021	Performance data added
1.0	02/2022	Release



1. Key features

- 4-Series form factor, for drop-in replacement
- Ultra-low power consumption: < 2 mW
- Very low peak current: < 4 mA
- Simple digital communication UART interface
- Factory calibrated with temperature compensation
- Fast response time, T90 < 30s
- ATEX & IECEx certified



2. Description

Mulberry sensors are cutting-edge NDIR (Non-dispersive Infrared), dual-channel, gas sensors integrated in a standard 4-series form factor. They are based on eLichens' patented technology including a proprietary IR micro-source, patented optical design and advanced signal processing algorithms. It provides Mulberry sensors the lowest power consumption on the market in a compact formfactor. This ultra-low power is a key differentiator allowing the development of innovative battery-powered safety products.



3. Specifications

Functional specifications @ 25°C, 50%RH, 1atm & 3.3V	
Technology	Non-Dispersive Infrared (NDIR), Dual-channel
Gas sampling method	Diffusion
Target gas	CH4
Measurement range	0...5% vol.
Data rate	2 measurements / second
Accuracy	±0.1% vol. or ±5% of reading (whichever is greater)
Resolution	0.05% vol.
Warm up time	30 seconds
Response time T₉₀	< 30 seconds
Long-term stability	±0.1% vol. or ±5% of reading, per month
Lifetime	>5 years
Environmental specifications	
Operating temperature range	-20...50°C
Operating humidity range	0...95%RH, non-condensing
Storage temperature range	-20...50°C
Electrical specifications @ 25°C, 50%RH & 1atm	
Supply voltage	3.0...5.0 V
Average power consumption	< 2.0 mW @3.3V
Average current consumption	< 610 µA
Peak current	< 4.0 mA
Output	Digital, UART



4. Outline

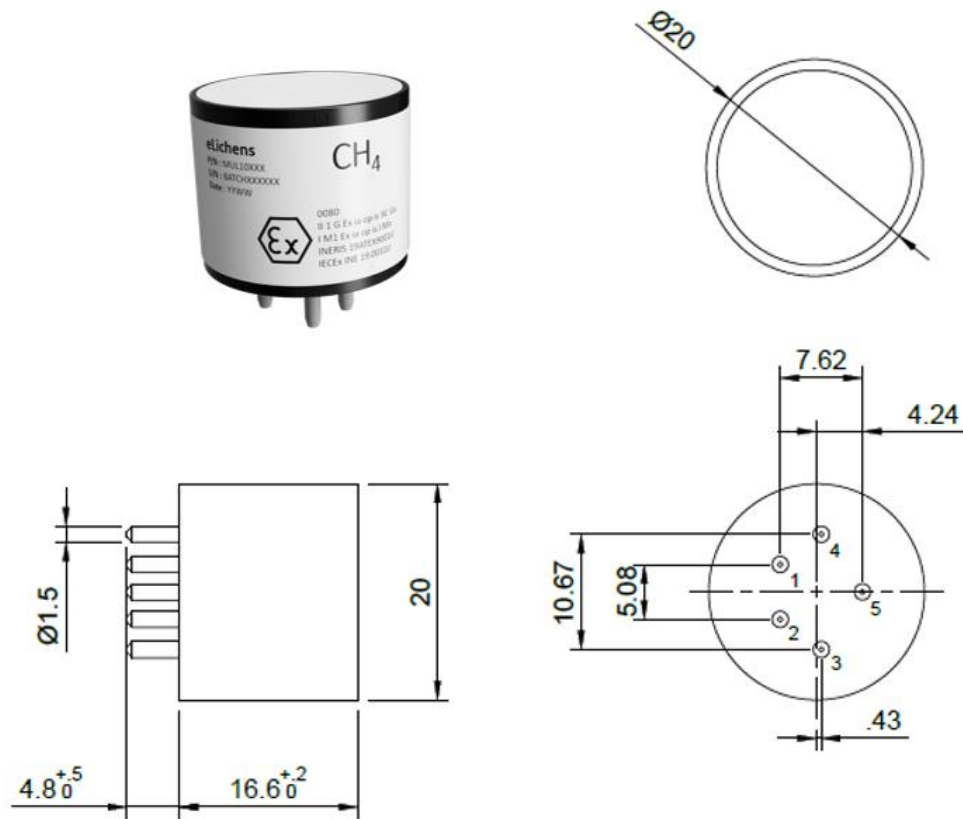

All dimensions are in millimeters [mm]

5. Pinout

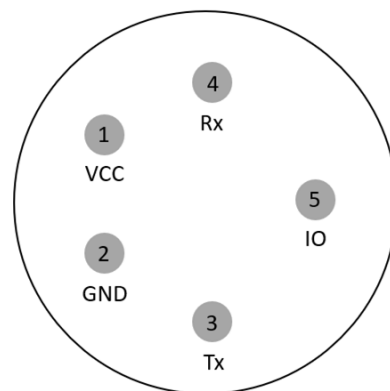

Bottom view

By default, pin 5 is configured as Chip Select.

It can be customized into an IRQ, enable or other. Please contact us.



6. Intrinsic safety

Mulberry sensors are safe to use in explosive atmosphere because they are intrinsically safe regarding the ATEX and IECEx certification. They are certified by the certification body INERIS (code 0080).

Mulberry sensors will be certified for intrinsic safety including the following certifications:

- EN 60079-0: 2018
- EN 60079-11: 2012
- EN 60079-28: 2015
- EN 50303: 2000

ATEX certificate number: INERIS 19ATEX9001U issue 3

Mulberry sensor will respect these two markings:

- Ex ia op is IIC Ga
- Ex ia op is I Ma

The marking on the sensor is:



0080
 II 1G / Ex ia op is IIC Ga
 I M1 / Ex ia op is I Ma
 INERIS 19ATEX9001U
 IECEx INE 19 0031U

Mulberry sensors can be used in explosive gas atmosphere and in Mines susceptible to firedamp. For both areas, the sensors are safe to be used in Zone 0, atmosphere area having a permanent and/or prolonged risk of explosions.

Equipment category and Equipment protection level (EPL)

The sensor is intrinsically safe if the implementation of the sensor complies with the following rules:

- Electrical parameters (U_i , I_i , P_i , C_i , L_i) are limiting to intrinsic values according to the standard EN 60079-11: 2012.
- Mulberry sensor is compliant with the ATEX temperature class T4 for a maximal ambient temperature of +60°C.

Intrinsic input parameters:

- $U_i = 5.0V$
- $I_i = 1.2A$
- $P_i = 1.2W$
- $C_i = 39\mu F$
- $L_i = 0\mu H$



7. Performance Data

7.1. Current Profile

Mulberry has a <4mA peak current and an average current <0.61mA with 2 pulses per second, as exhibited in the figure below.

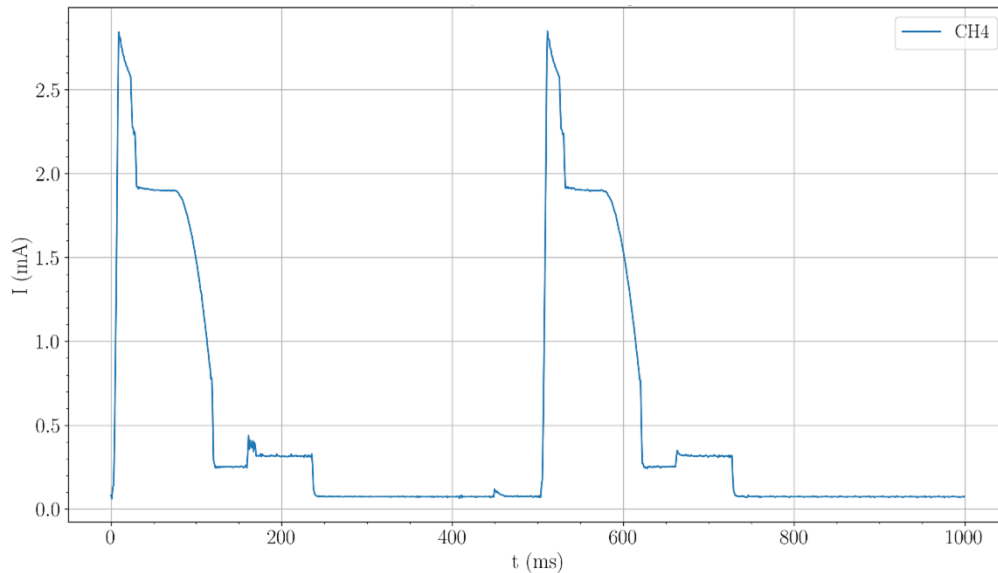

7.2. Sensor linearity

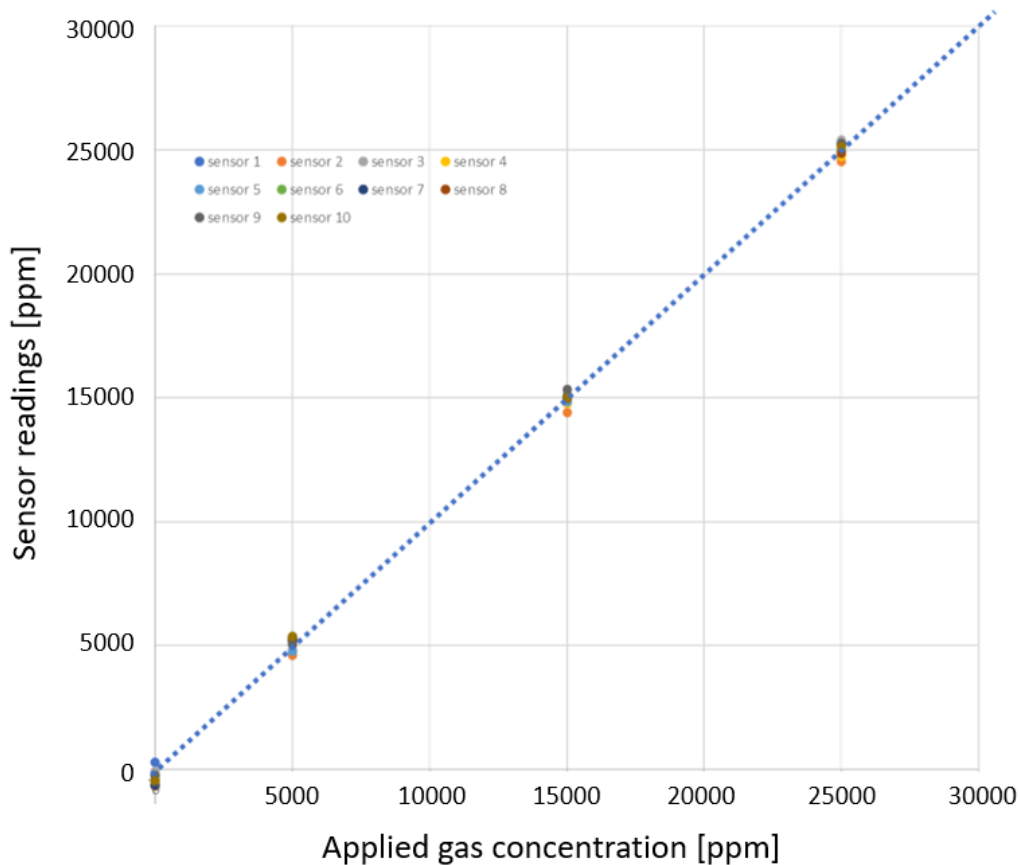



7.3. Response Time

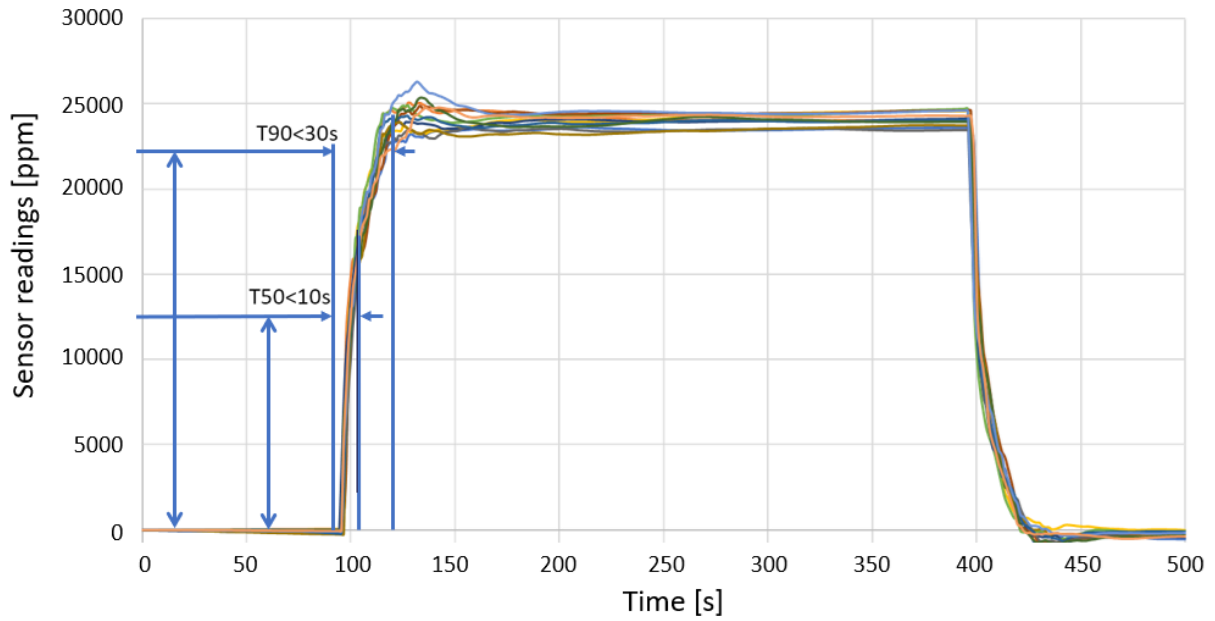

7.4. Temperature stability, @ 0ppm & 25000ppm

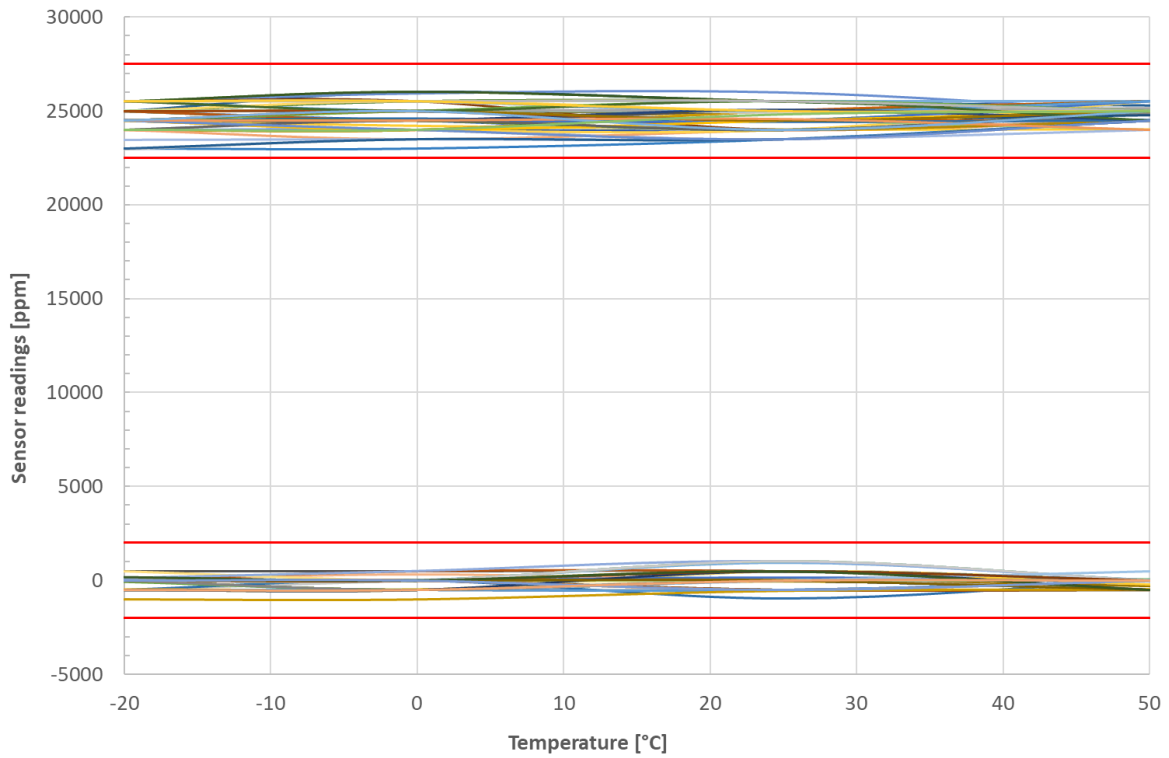



7.5. Temperature cycles, 2°C / minute

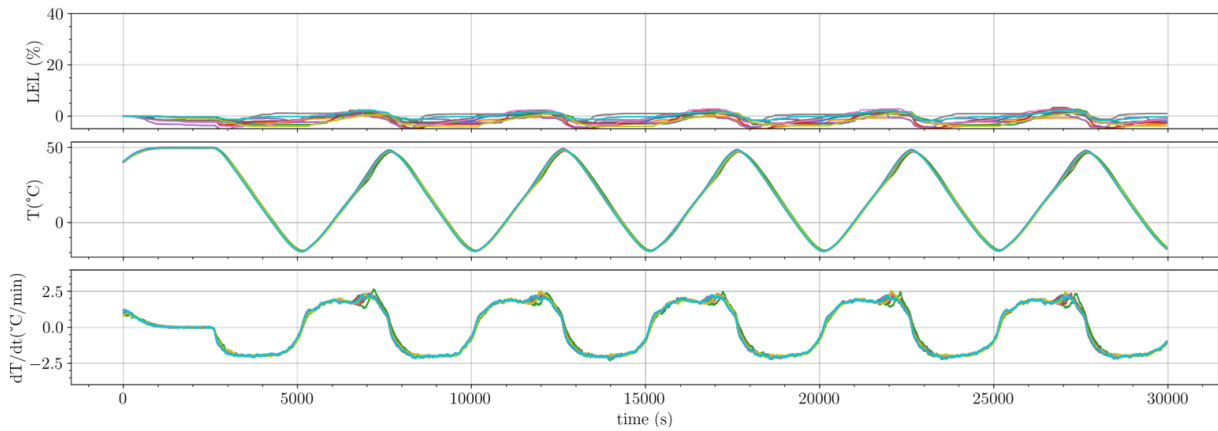

7.6. Sensitivity to other gases

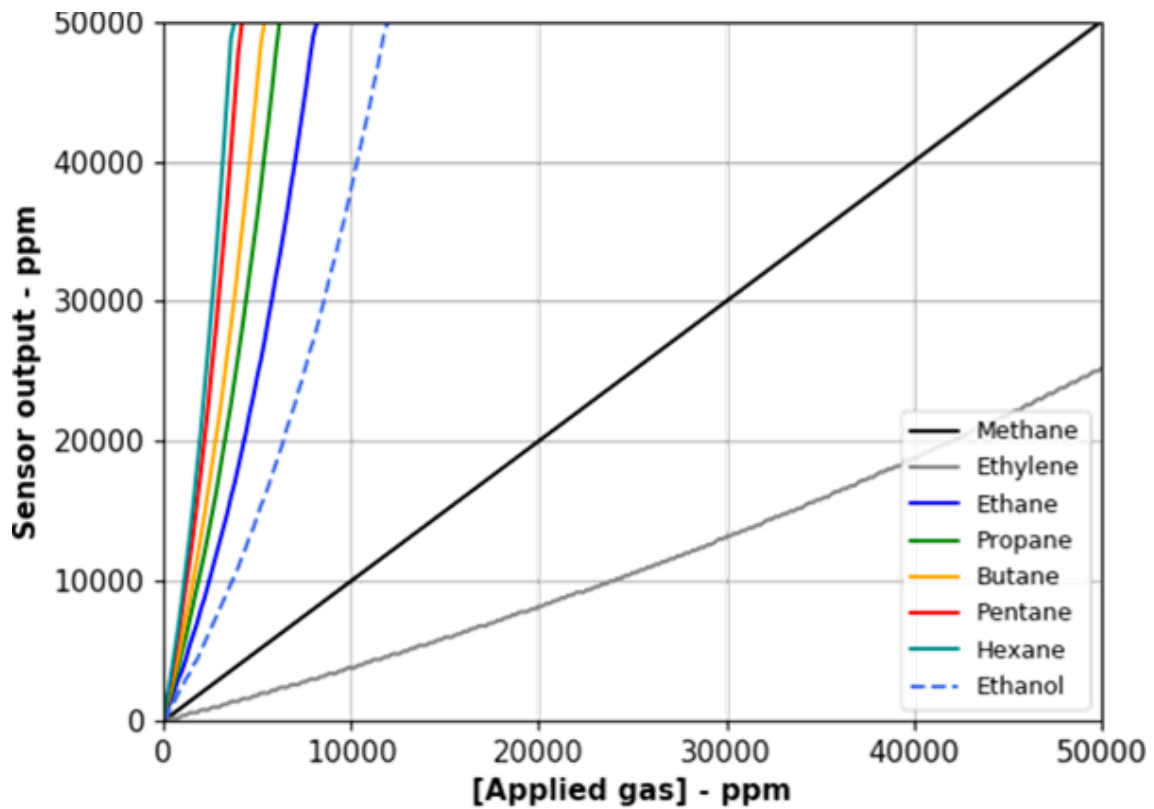



8. Part Number

Mulberry sensors can be ordered via the following article numbers.

Target gas	Full scale	Temperature range	App Code	Part number
CH4	0...5%vol.	-20 to 50°C	442	MUL-12-442

For further information, please contact:

eLichens
 17 rue Félix Esclançon
 38000 Grenoble
 FRANCE

info@elichens.com
 www.elichens.com